



FDA

DOUBLE INLET
CENTRIFUGAL FAN
with Forward Wheels



FDA Series

DOUBLE INLET CENTRIFUGAL FAN with Forward Wheels



Kruger Ventilation Industries certifies that the **FDA series : version S, C, T and X - model 200 to 1000** shown herein is licensed to bear the AMCA Seal. The ratings shown are based on tests and procedures performed in accordance with AMCA publication 211 and AMCA publication 311 and comply with the requirements of the AMCA Certified Ratings Program.



FDA Series Double Inlet Forward Curved Centrifugal Fans

The FDA series is DIDW centrifugal fans with forward curved impellers. The fans are suitable for supply or extract applications in commercial, process and industrial HVAC systems.

Sizes of this series are in accordance with AMCA standard 99-0098-76 R20.

	Model 315 to 710	Model 800 to 1400
Type S-C	I	I
Type T	II	I
Type X	III	II

Type / Operating Limit

Each fan type has its maximum operating speed and power due to its mechanical design.

The operating limit of FDA series - fan type is design to meet the requirement of class I, II and III limit as defined in AMCA standard 99-2408-69.

The FDA series is available in type S, C, T and X.

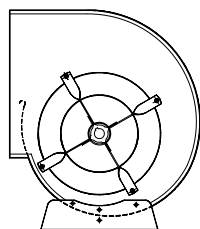

Type S

This type is supplied with mounting feet and can be mounted in three different orientations. The construction is mainly for OEM application which only subject to testing and approval.

Fan Size : 160 to 710
Volume : 1000 to 50000 m³/h
Total Pressure : up to 1400 Pa

Performance of 160 and 180 are not AMCA licensed.

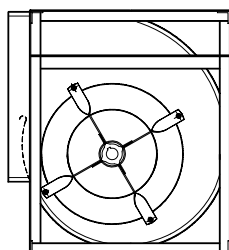

Type C

This type has a frame fitted on both sides of the fan which gives better strength and rigidity. It allows mounting in four different orientations.

Fan Size : 160 to 710
Volume : 1000 to 50000 m³/h
Total Pressure : up to 1400 Pa

Performance of 160 and 180 are not AMCA licensed.

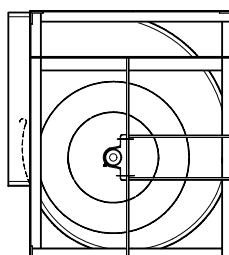

Type T

This type has a welded frame giving increased stiffness and rigidity required for higher operating performance.

Fan Size : 250 to 1400
Volume : 2500 to 250 000 m³/h
Total Pressure : up to 1600 Pa

Performance of 1120, 1250 & 1400 are not AMCA licensed.

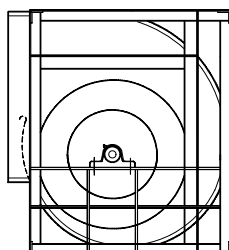

Type X

The structure is similar to type T but utilizes enhanced bearings to support higher dynamic load necessary for the increased performance.

Fan Size : 560 to 1400
Volume : 1500 to 250 000 m³/h
Total Pressure : up to 1800 Pa

Performance of 1120, 1250 & 1400 are not AMCA licensed.

FDA Twin Fan

FDA series are also available in twin fan version, with two double inlet fans mounted on the same shaft.

To select for twin fans, use the curves of single fan with the following factors :-

Volume	x 2
Absorbed Power	x 2.15
Speed	x 1.05
Noise	+ 3 dB

This series is available in Type S2, C2 or T2, fig. 2 shows the sizes and type available.

Performances of twin fan series are not AMCA licensed.

<p>Type S2 Size: 250 to 500 Vol.: 5000 to 50000m³/h</p>	
<p>Type C2 Size: 250 to 500 Vol.: 5000 to 50000m³/h</p>	
<p>Type T2 Size: 355 to 630 Vol.: 10000 to 80000m³/h</p>	

Fig.2



Wheel

The wheel of FDA series has forward curved blades manufactured in galvanised sheet steel.

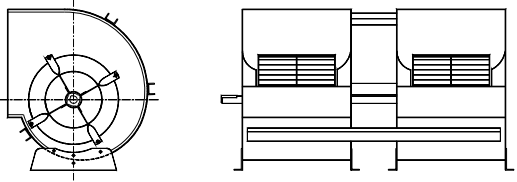
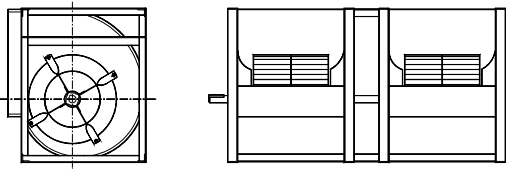
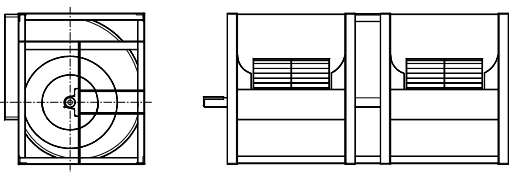
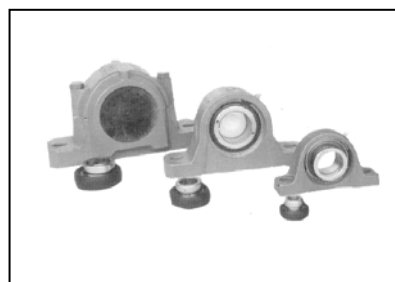
Housing

For all sizes except 1250 and above, the housing is manufactured in galvanized sheet steel with the housing fixed to the side plates in "pittsburg lock" form system.

Housings for 1250 and 1400 are manufactured in mild steel finished with polyester powder coating.

Frame



The frame is manufactured with galvanized angular bars for type "C". For type "T" and "X", they are manufactured with sections of steel and finished with polyester powder coating.

Shaft

Shafts are manufactured from C45 carbon steel using an automatic process for positioning and cutting of the keyways. All dimensional tolerances of the shaft are fully checked to ensure a precision fit and then coated with an anti-corrosion varnish after assembly.

Bearings

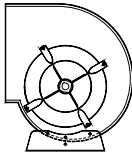
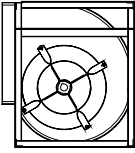
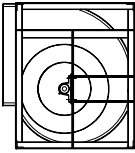
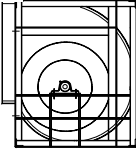
Bearings used are either deep groove ball bearing type with an eccentric locking collar or an adapter sleeve, or spherical roller bearings type sealed at both sides for different duty application as classified below:

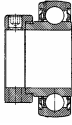
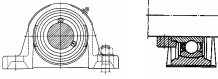
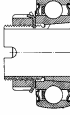
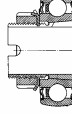
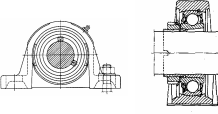
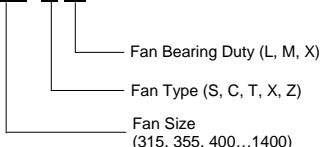
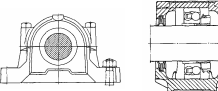
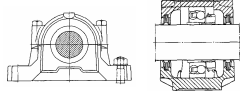
		Mounted in a rubber housing		Mounted on cast iron supports with grease point				
Fan Type	S		C		T		X	
	Bearing Duty	SL Light Duty		CL Light Duty		TL Light Duty		—
		SM Medium Duty		CM Medium Duty		TM Medium Duty		XM Medium Duty
	eg. Model: FDA 450 C M			TX Extra Heavy Duty		XX Extra Heavy Duty		
	 <p>— Fan Bearing Duty (L, M, X) — Fan Type (S, C, T, X, Z) — Fan Size (315, 355, 400...1400)</p>							

The bearings are lubricated for life and maintenance-free. If re-lubrication is necessary, it is recommended to use lithium base grease suitable for all temperatures within the operational limits.

Balancing Quality

All wheels are statically and dynamically balanced to ISO1940 and AMCA 204 – G2.5 standards.

All fans after assembly are trim-balanced to ISO1940 and AMCA 204 – G2.5 standard.

Accessories

Casing Drain

This option is available when using fans exposed to the atmosphere or operating in high humidity conditions.

Outlet Flanges

Outlet flanges are available upon request.

Inspection Doors

The inspection door can be supplied upon request. It can be supplied in one of the three position (P3, P4 & P5).

Guards

Inlet guards, discharge guards and non-drive end shaft guards are available on request.

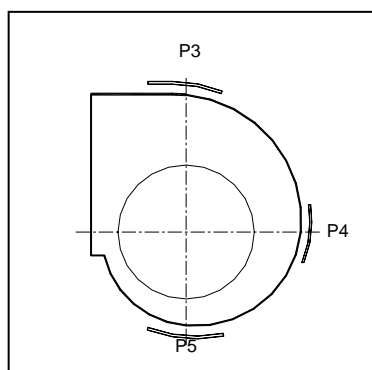

Fan Rotation and Discharge

The rotation and discharge of the fan is in accordance with AMCA standard 99-2406-83. The direction of rotation is determined from the drive side of the fan [refer Fig. 3]: -

- CW - clockwise rotation
- CCW - counter-clockwise rotation

	90°	180°	270°	360°
CW				
CCW				

Fig. 3 - Fan rotation and discharge

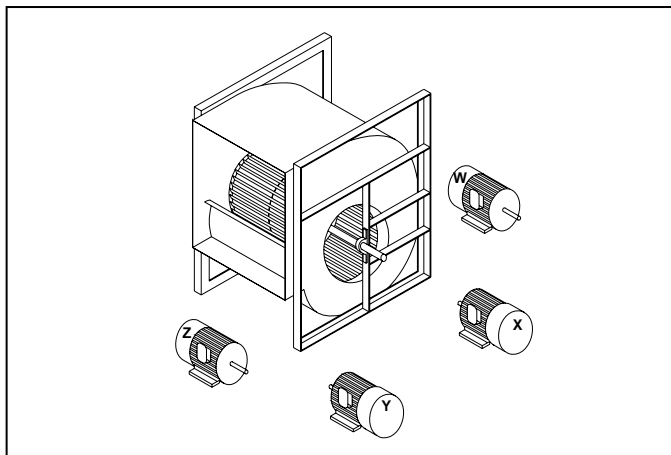

Fig. 4 - Motor Position

Motor Position

The position of the motor for belt drive centrifugal fan is in accordance with AMCA standard 99-2407-66.

Location of motor is determined by facing the drive side of fan and designating the positions by letters W, X, Y, or Z. [refer to Fig.4]

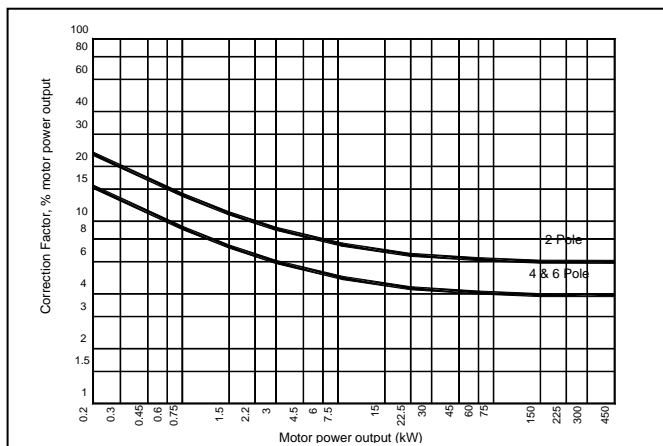

Fig. 5 – Recommended for compensation

Motor Selection

The power curve shown on each performance curve represents the absorbed power at the shaft of the fan measured in kW.

To determine the power of the motor to be installed, a correction factor as shown in fig. 5 should be applied to compensate for transmission losses.

For conversion to horsepower (HP), use multiplying factor 1.34.

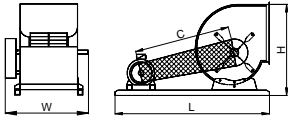
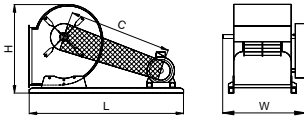
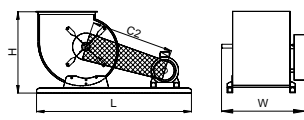
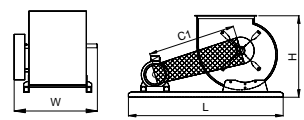
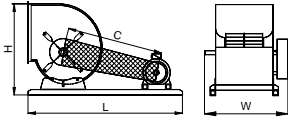
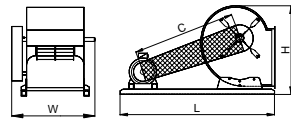
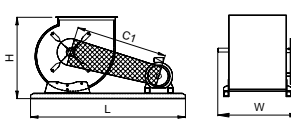
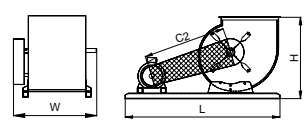
CW 90° (Pos Z)

CW 270° (Pos W)

CW 360° (Pos W)

CW 360° (Pos Z)

CCW 90° (Pos W)

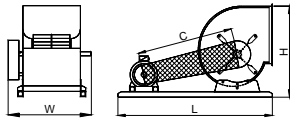
CCW 270° (Pos Z)

CCW 360° (Pos W)

CCW 360° (Pos Z)

Model	Motor Frame Size	90°/ 270°							360°					
		C (90°)	C (270°)	L	W	H (90°)	H (270°)	* Wt (kg)	C1	C2	L	W	H	* Wt (kg)
160	63	307	319	560	398	362	364	11	366	315	600	398	330	11
	71	337	348	600	398	362	364	11	397	345	640	398	330	12
	80	347	356	620	398	362	364	11	427	375	680	398	330	12
	90	377	383	660	398	362	364	12	456	404	720	398	330	12
	100	406	411	700	398	362	364	12	486	434	760	398	330	12
180	63	317	334	580	422	396	400	12	392	337	640	422	356	13
	71	327	342	600	422	396	400	12	403	347	660	422	356	13
	80	357	369	640	422	396	400	13	432	377	700	422	356	13
	90	386	395	680	422	396	400	13	461	405	740	422	356	13
	100	415	422	720	422	396	400	13	491	435	780	422	356	13
200	63	348	368	620	450	436	434	14	402	338	660	450	388	14
	71	358	376	640	450	436	434	14	413	348	680	450	388	14
	80	387	402	680	450	436	434	14	442	376	720	450	388	14
	90	415	428	720	450	436	434	14	450	385	740	450	388	14
	100	444	454	760	450	436	434	14	479	413	780	450	388	15
	112	471	479	800	450	436	434	15	506	440	820	450	388	15
225	63	375	401	660	482	480	479	16	449	374	720	482	424	16
	71	385	409	680	482	480	479	16	479	403	760	482	424	16
	80	413	434	720	482	480	479	16	508	431	800	482	424	16
	90	461	478	780	482	480	479	16	536	459	840	482	424	17
	100	469	485	800	482	480	479	16	565	487	880	482	424	17
250	71	432	461	740	516	520	521	18	526	441	820	516	461	18
	80	441	468	760	516	520	521	18	554	468	860	516	461	18
	90	469	492	800	516	520	521	18	582	496	900	516	461	18
	100	497	517	840	516	520	521	18	610	523	940	516	461	19
	112	543	560	900	516	520	521	18	636	549	980	516	461	19
280	71	439	475	760	586	578	577	23	548	456	860	586	509	23
	80	447	481	780	586	578	577	23	557	464	880	586	509	24
	90	474	504	820	586	578	577	23	584	490	920	586	509	24
	100	501	528	860	586	578	577	23	611	517	960	586	509	24
	112	527	550	900	586	578	577	24	636	542	1000	586	509	24
315	71	483	527	820	630	641	642	28	589	486	920	630	559	29
	80	491	532	840	630	641	642	29	616	513	960	630	559	29
	90	517	555	880	630	641	642	29	623	519	980	630	559	29
	100	544	578	920	630	641	642	29	650	545	1020	630	559	30
	112	569	599	960	630	641	642	29	675	569	1060	630	559	30
355	71	540	596	900	702	697	712	35	649	535	1000	702	620	36
	80	548	601	920	702	697	712	35	675	560	1040	702	620	36
	90	555	605	940	702	697	712	35	701	585	1080	702	620	36
	100	582	628	980	702	697	712	36	708	591	1100	702	620	36
	112	606	648	1020	702	697	712	36	752	634	1160	702	620	37
400	71	559	632	940	756	774	794	45	671	543	1040	756	689	45
	80	566	636	960	756	774	794	45	678	549	1060	756	689	45
	90	572	639	980	756	774	794	45	721	590	1120	756	689	46
	100	598	660	1020	756	774	794	45	747	614	1160	756	689	46
	112	622	679	1030	756	774	794	45	770	637	1200	756	689	46
400	132	637	688	1100	756	774	794	46	794	659	1250	756	689	46
	160	644	688	1140	756	774	794	46	810	673	1300	756	689	47

* The above weight does not include motor and drive unit as these will vary with supplier.

All Dimensions in mm.

CW 90° (Pos Z)



CW 270° (Pos W)

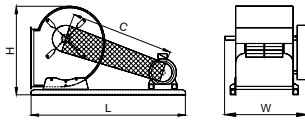

CW 360° (Pos W)

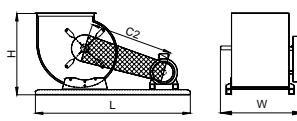

CW 360° (Pos Z)

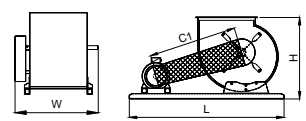

CCW 90° (Pos W)

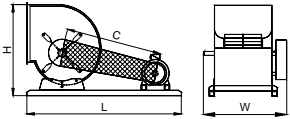

CCW 270° (Pos Z)

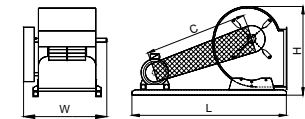

CCW 360° (Pos W)

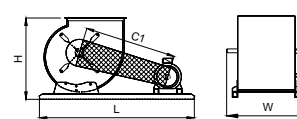

CCW 360° (Pos Z)

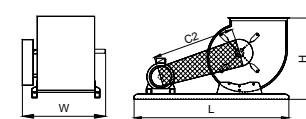

Model	Motor Frame Size	90° / 270°							360°					
		C (90°)	C (270°)	L	W	H (90°)	H (270°)	* Wt (kg)	C1	C2	L	W	H	* Wt (kg)
450	71	616	703	1020	844	862	888	56	746	606	1140	844	769	57
	80	641	723	1060	844	862	888	57	771	629	1180	844	769	57
	90	648	726	1080	844	862	888	57	824	679	1250	844	769	58
	100	673	747	1120	844	862	888	57	859	712	1300	844	769	58
	112	697	765	1160	844	862	888	57	891	743	1350	844	769	58
	132	711	774	1200	844	862	888	57	915	765	1400	844	769	58
	160	776	828	1300	844	862	888	58	929	778	1450	844	769	59
500	80	705	793	1160	954	963	986	84	847	692	1300	954	850	85
	90	711	796	1180	954	963	986	84	881	724	1350	954	850	85
	100	717	799	1200	954	963	986	84	915	756	1400	954	850	86
	112	750	826	1250	954	963	986	85	947	787	1450	954	850	86
	132	773	843	1300	954	963	986	85	970	808	1500	954	850	87
	160	837	896	1400	954	963	986	86	984	820	1550	954	850	87
560	80	768	873	1250	1030	1069	1097	97	965	793	1450	1030	942	99
	90	802	901	1300	1030	1069	1097	98	998	824	1500	1030	942	99
	100	836	929	1350	1030	1069	1097	98	1032	856	1550	1030	942	100
	112	821	913	1350	1030	1069	1097	98	1064	886	1600	1030	942	100
	132	844	928	1400	1030	1069	1097	98	1086	906	1650	1030	942	100
	160	907	980	1500	1030	1069	1097	99	1099	918	1700	1030	942	101
630	80	840	961	1350	1122	1197	1220	119	1038	848	1550	1122	1055	120
	90	873	988	1400	1122	1197	1220	119	1071	877	1600	1122	1055	121
	100	860	974	1400	1122	1197	1220	119	1103	908	1650	1122	1055	121
	112	891	999	1450	1122	1197	1220	120	1134	936	1700	1122	1055	122
	132	913	1014	1500	1122	1197	1220	120	1155	955	1750	1122	1055	122
	160	926	1018	1550	1122	1197	1220	120	1167	964	1800	1122	1055	122
710	80	930	1065	1500	1264	1376	1398	149	1122	907	1700	1264	1200	151
	90	963	1091	1550	1264	1376	1398	149	1154	936	1750	1264	1200	152
	100	950	1077	1550	1264	1376	1398	149	1141	923	1750	1264	1200	152
	112	981	1102	1600	1264	1376	1398	150	1171	950	1800	1264	1200	152
	132	1003	1117	1650	1264	1376	1398	151	1239	1013	1900	1264	1200	154
	160	1064	1165	1750	1264	1376	1398	152	1298	1068	2000	1264	1200	155
	180	1087	1182	1800	1264	1376	1398	152	1369	1136	2100	1264	1200	156
	200	1160	1245	1900	1264	1376	1398	154	1441	1206	2200	1264	1200	157

* The above weight does not include motor and drive unit as these will vary with supplier.

All Dimensions in mm.

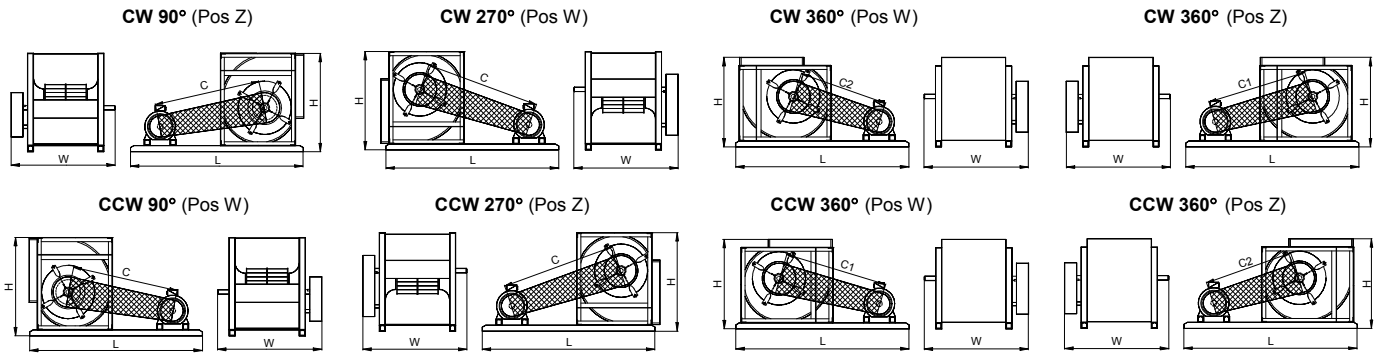

Model	Motor Frame Size	90° / 270°						360°					
		C (90°)	C (270°)	L	W	H	* Wt (kg)	C1	C2	L	W	H	* Wt (kg)
180	63	308	320	560	422	376	14	337	280	600	422	363	14
	71	339	349	600	422	376	14	367	310	640	422	363	14
	80	350	357	620	422	376	14	396	339	680	422	363	14
	90	379	385	660	422	376	14	425	367	720	422	363	14
	100	409	413	700	422	376	14	454	396	760	422	363	15
200	63	326	342	580	450	410	15	366	300	640	450	383	15
	71	336	351	600	450	410	15	376	310	660	450	383	15
	80	366	378	640	450	410	15	405	338	700	450	383	16
	90	396	405	680	450	410	15	434	366	740	450	383	16
	100	425	432	720	450	410	16	463	395	780	450	383	16
	112	453	458	760	450	410	16	510	442	840	450	383	16
225	63	349	372	620	482	455	17	393	319	680	482	422	17
	71	360	380	640	482	455	17	422	347	720	482	422	17
	80	389	406	680	482	455	17	431	356	740	482	422	17
	90	418	432	720	482	455	17	459	383	780	482	422	18
	100	447	458	760	482	455	18	487	411	820	482	422	18
	112	474	483	800	482	455	18	533	457	880	482	422	18
250	71	389	415	680	516	500	20	449	365	760	516	458	21
	80	418	441	720	516	500	21	477	392	800	516	458	21
	90	447	466	760	516	500	21	505	419	840	516	458	21
	100	475	492	800	516	500	21	533	446	880	516	458	21
	112	502	516	840	516	500	21	559	472	920	516	458	22
280	71	433	464	740	586	558	26	491	400	820	586	506	26
	80	441	471	760	586	558	26	518	426	860	586	506	26
	90	469	495	800	586	558	26	545	452	900	586	506	27
	100	497	520	840	586	558	26	572	478	940	586	506	27
	112	543	562	900	586	558	27	597	503	980	586	506	27
	132	601	615	980	586	558	27	654	559	1060	586	506	27
315	71	460	500	780	630	618	30	534	433	880	630	558	31
	80	488	524	820	630	618	30	561	459	920	630	558	31
	90	515	547	860	630	618	31	587	484	960	630	558	31
	100	542	571	900	630	618	31	614	509	1000	630	558	31
	112	568	594	940	630	618	31	638	533	1040	630	558	32
	132	625	645	1020	630	618	32	694	587	1120	630	558	32
355	71	496	547	840	702	694	39	593	479	960	702	618	40
	80	523	570	880	702	694	39	601	485	980	702	618	40
	90	549	592	920	702	694	39	626	509	1020	702	618	40
	100	576	615	960	702	694	40	652	534	1060	702	618	40
	112	601	636	1000	702	694	40	695	575	1120	702	618	40
	132	657	685	1080	702	694	40	669	628	1200	702	618	41
400	71	561	621	920	756	776	49	630	527	1040	756	690	49
	80	569	626	940	756	776	49	677	550	1080	756	690	49
	90	595	647	980	756	776	49	683	555	1100	756	690	50
	100	621	669	1020	756	776	49	727	597	1160	756	690	50
	112	664	708	1080	756	776	49	750	619	1200	756	690	50
	132	719	756	1160	756	776	50	774	641	1250	756	690	50
	160	776	806	1250	756	776	50	888	752	1400	756	690	51

* The above weight does not include motor and drive unit as these will vary with supplier.

All Dimensions in mm.

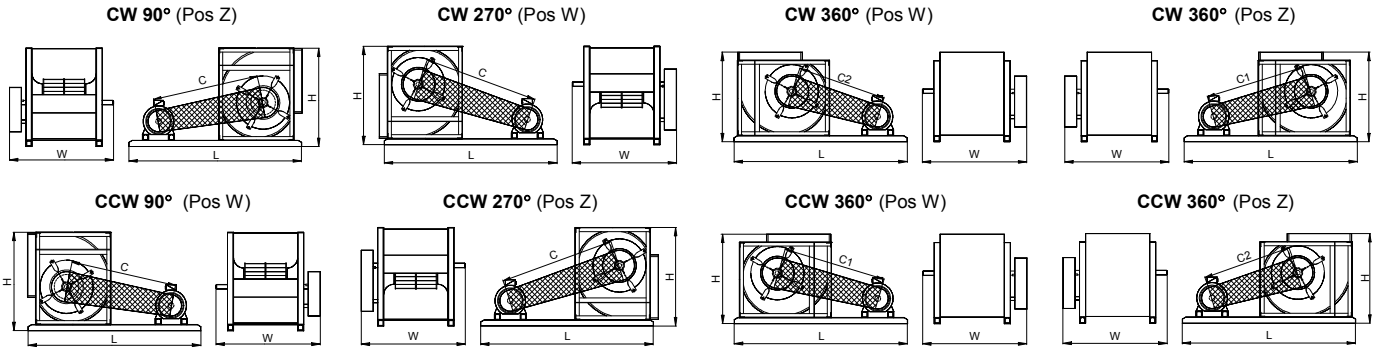

Model	Motor Frame Size	90° / 270°						360°					
		C (90°)	C (270°)	L	W	H	* Wt (kg)	C1	C2	L	W	H	* Wt (kg)
450	71	607	680	980	844	867	59	708	571	1120	844	766	60
	80	633	701	1020	844	867	59	733	593	1160	844	766	60
	90	658	722	1060	844	867	60	757	615	1200	844	766	60
	100	684	743	1100	844	867	60	791	647	1250	844	766	61
	112	707	763	1140	844	867	60	824	678	1300	844	766	61
	132	741	790	1200	844	867	60	846	699	1350	844	766	61
500	160	856	894	1350	844	867	61	958	801	1500	844	766	62
	80	661	740	1080	954	968	88	779	629	1250	954	850	90
	90	686	760	1120	954	968	89	812	659	1300	954	850	90
	100	711	780	1160	954	968	89	845	691	1350	954	850	90
	112	734	799	1200	954	968	89	877	720	1400	954	850	91
560	132	805	861	1300	954	968	90	899	740	1450	954	850	91
	160	870	917	1400	954	968	91	961	799	1550	954	850	92
	80	734	827	1180	1030	1080	109	852	686	1350	1030	942	110
	90	739	830	1200	1030	1080	109	884	714	1400	1030	942	110
	100	773	858	1250	1030	1080	109	916	744	1450	1030	942	111
630	112	804	884	1300	1030	1080	110	947	773	1500	1030	942	111
	132	875	945	1400	1030	1080	110	968	792	1550	1030	942	112
	160	938	998	1500	1030	1080	111	1076	895	1700	1030	942	113
	80	829	937	1300	1122	1207	121	967	782	1500	1122	1048	123
	90	862	964	1350	1122	1207	122	998	811	1550	1122	1048	123
	100	848	950	1350	1122	1207	122	1031	840	1600	1122	1048	124
	112	879	975	1400	1122	1207	122	1061	868	1650	1122	1048	124
710	132	948	1034	1500	1122	1207	123	1082	886	1700	1122	1048	125
	160	1010	1085	1600	1122	1207	124	1140	940	1800	1122	1048	125
	180	1082	1149	1700	1122	1207	125	1211	1008	1900	1122	1048	126
	80	875	1002	1400	1264	1382	156	1048	840	1650	1264	1200	160
	90	907	1028	1450	1264	1382	157	1080	868	1700	1264	1200	160
	100	941	1055	1500	1264	1382	158	1112	897	1750	1264	1200	161
	112	972	1080	1550	1264	1382	158	1142	924	1800	1264	1200	161
	132	993	1095	1600	1264	1382	159	1162	941	1850	1264	1200	162
710	160	1054	1144	1700	1264	1382	160	1220	994	1950	1264	1200	163
	180	1126	1207	1800	1264	1382	161	1290	1061	2050	1264	1200	164
	200	1199	1272	1900	1264	1382	163	1313	1082	2100	1264	1200	165

* The above weight does not include motor and drive unit as these will vary with supplier.

All Dimensions in mm.

CW 90° (Pos Z)

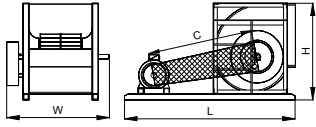

CW 270° (Pos W)

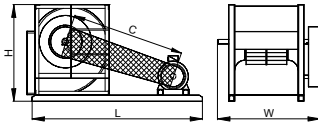

CW 360° (Pos W)

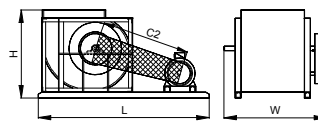

CW 360° (Pos Z)

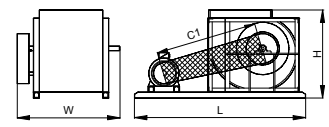

CCW 90° (Pos W)

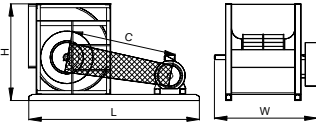

CCW 270° (Pos Z)

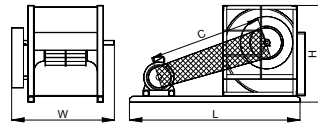

CCW 360° (Pos W)

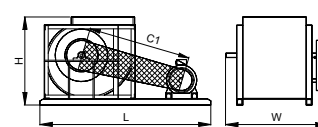

CCW 360° (Pos Z)

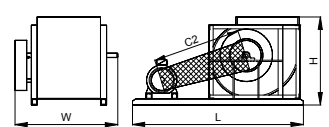

Model	Motor Frame Size	90°/ 270°						360°					
		C (90°)	C (270°)	L	W	H	* Wt (kg)	C1	C2	L	W	H	* Wt (kg)
250	90	447	466	760	568	500	27	505	419	840	568	458	27
	100	475	492	800	568	500	27	533	446	880	568	458	27
	112	502	516	840	568	500	27	559	472	920	568	458	28
	132	561	570	920	568	500	28	616	529	1000	568	458	28
	160	653	657	1040	568	500	28	706	618	1120	568	458	29
280	100	497	520	840	618	558	33	572	478	940	618	506	34
	112	543	562	900	618	558	34	597	503	980	618	506	34
	132	601	615	980	618	558	34	654	559	1060	618	506	34
	160	672	680	1080	618	558	35	743	647	1180	618	506	35
315	100	542	571	900	662	618	37	614	509	1000	662	558	37
	112	568	594	940	662	618	37	638	533	1040	662	558	38
	132	625	645	1020	662	618	38	694	587	1120	662	558	38
	160	715	728	1140	662	618	38	791	684	1250	662	558	39
355	100	576	615	960	748	694	53	652	534	1060	748	618	53
	112	620	654	1020	748	694	53	695	575	1120	748	618	53
	132	676	704	1100	748	694	53	749	628	1200	748	618	54
	160	745	766	1200	748	694	54	816	693	1300	748	618	54
	180	823	839	1300	748	694	54	892	769	1400	748	618	55
400	112	664	708	1080	802	776	63	750	619	1200	802	690	64
	132	719	756	1160	802	776	64	823	689	1300	802	690	65
	160	826	854	1300	802	776	65	888	752	1400	802	690	65
	180	854	877	1350	802	776	65	914	778	1450	802	690	65
450	112	707	763	1140	908	867	70	824	678	1300	908	766	71
	132	741	790	1200	908	867	70	846	699	1350	908	766	71
	160	856	894	1350	908	867	71	958	807	1500	908	766	72
	180	883	916	1400	908	867	71	983	832	1550	908	766	72
	200	960	987	1500	908	867	72	1059	906	1650	908	766	73
500	112	734	799	1200	986	968	96	877	720	1400	986	850	98
	132	805	861	1300	986	968	97	899	740	1450	986	850	98
	160	870	917	1400	986	968	98	961	799	1550	986	850	99
	180	945	985	1500	986	968	99	1034	871	1650	986	850	100
	200	972	1008	1550	986	968	99	1109	944	1750	986	850	100
560	132	875	945	1400	1110	1080	127	1016	838	1600	1110	942	129
	160	938	998	1500	1110	1080	128	1076	895	1700	1110	942	130
	180	1012	1064	1600	1110	1080	129	1100	917	1750	1110	942	130
	200	1038	1085	1650	1110	1080	129	1173	989	1850	1110	942	131
630	132	948	1034	1500	1196	1207	159	1082	886	1700	1196	1048	161
	160	1010	1085	1600	1196	1207	160	1140	940	1800	1196	1048	161
	180	1082	1149	1700	1196	1207	161	1211	1008	1900	1196	1048	162
	200	1107	1169	1750	1196	1207	161	1235	1030	1950	1196	1048	163
710	132	993	1095	1600	1310	1382	224	1162	941	1850	1310	1200	227
	160	1054	1144	1700	1310	1382	225	1220	994	1950	1310	1200	228
	180	1126	1207	1800	1310	1382	226	1290	1061	2050	1310	1200	229
	200	1199	1272	1900	1310	1382	228	1313	1082	2100	1310	1200	230
	225	1268	1333	2000	1310	1382	229	1379	1146	2200	1310	1200	231

* The above weight does not include motor and drive unit as these will vary with supplier.

All Dimensions in mm.

OVERALL DIMENSION - FDA "T" SERIES

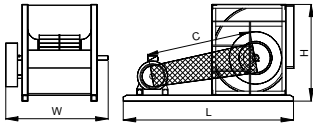
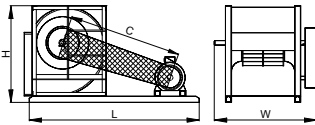
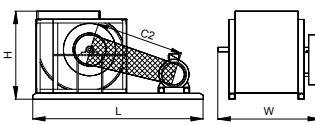
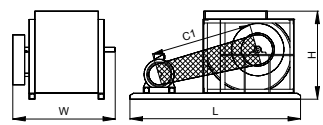
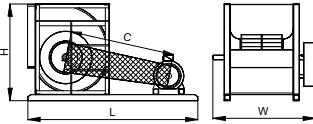
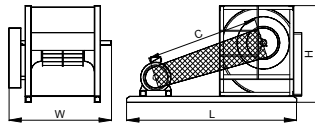
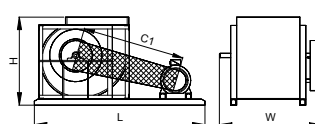
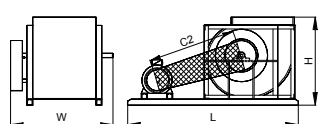
CW 90° (Pos Z)

CW 270° (Pos W)

CW 360° (Pos W)

CW 360° (Pos Z)

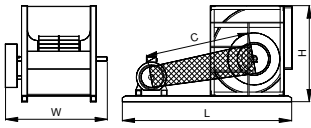
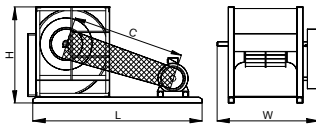
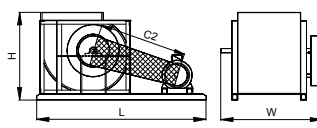
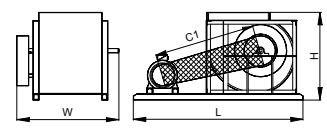
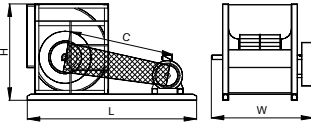
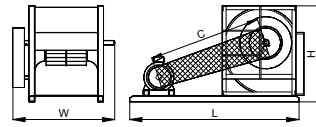
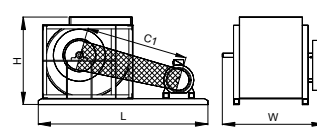
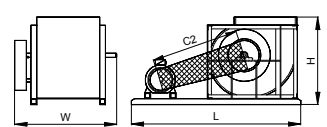
CCW 90° (Pos W)

CCW 270° (Pos Z)

CCW 360° (Pos W)

CCW 360° (Pos Z)

Model	Motor Frame Size	90° / 270°						360°					
		C (90°)	C (270°)	L	W	H	* Wt (kg)	C1	C2	L	W	H	* Wt (kg)
800	90	986	1130	1550	1418	1548	273	1187	955	1850	1418	1334	276
	100	1018	1156	1600	1418	1548	273	1218	983	1900	1418	1334	277
	112	1048	1180	1650	1418	1548	274	1247	1009	1950	1418	1334	278
	132	1115	1235	1750	1418	1548	275	1267	1024	2000	1418	1334	278
	160	1174	1283	1850	1418	1548	276	1370	1120	2150	1418	1334	280
	180	1197	1300	1900	1418	1548	277	1391	1139	2200	1418	1334	281
	200	1269	1362	2000	1418	1548	278	1461	1206	2300	1418	1334	282
	225	1336	1420	2100	1418	1548	279	1526	1268	2400	1418	1334	283
900	100	1140	1302	1750	1596	1728	330	1330	1067	2050	1596	1488	333
	112	1169	1325	1800	1596	1728	330	1358	1092	2100	1596	1488	334
	132	1189	1338	1850	1596	1728	331	1421	1148	2200	1596	1488	335
	160	1293	1425	2000	1596	1728	333	1476	1197	2300	1596	1488	336
	180	1315	1441	2050	1596	1728	333	1543	1260	2400	1596	1488	338
	200	1385	1501	2150	1596	1728	335	1564	1278	2450	1596	1488	338
1000	225	1451	1557	2250	1596	1728	336	1627	1338	2550	1596	1488	339
	100	1257	1440	1900	1754	1890	380	1486	1198	2250	1754	1620	384
	112	1241	1423	1900	1754	1890	380	1514	1222	2300	1754	1620	385
	132	1305	1475	2000	1754	1890	381	1532	1236	2350	1754	1620	386
	160	1361	1518	2100	1754	1890	383	1586	1282	2450	1754	1620	387
	180	1429	1575	2200	1754	1890	384	1651	1343	2550	1754	1620	388
	200	1451	1591	2250	1754	1890	384	1719	1405	2650	1754	1620	389
1120	225	1515	1644	2350	1754	1890	386	1781	1463	2750	1754	1620	391
	250	1581	1700	2450	1754	1890	387	1844	1523	2850	1754	1620	392
	112	1404	1603	2100	1830	2158	745	1676	1342	2500	1830	1850	755
	132	1423	1615	2150	1830	2158	746	1695	1356	2550	1830	1850	757
	160	1479	1658	2250	1830	2158	749	1749	1403	2650	1830	1850	759
	180	1547	1715	2350	1830	2158	751	1815	1464	2750	1830	1850	762
1250	200	1616	1773	2450	1830	2158	754	1883	1527	2850	1830	1850	765
	225	1680	1827	2550	1830	2158	757	1945	1585	2950	1830	1850	767
	250	1746	1882	2650	1830	2158	759	2008	1645	3050	1830	1850	770
	132	1564	1790	2350	2005	2435	1153	1873	1491	2800	2005	2080	1175
	160	1619	1831	2450	2005	2435	1158	1926	1537	2900	2005	2080	1180
	180	1687	1886	2550	2005	2435	1163	1992	1596	3000	2005	2080	1184
	200	1755	1943	2650	2005	2435	1168	2058	1657	3100	2005	2080	1189
1400	225	1819	1995	2750	2005	2435	1172	2120	1714	3200	2005	2080	1194
	250	1883	2049	2850	2005	2435	1177	2182	1772	3300	2005	2080	1199
	280	1943	2097	2950	2005	2435	1182	2240	1825	3400	2005	2080	1204
	315	2046	2186	3100	2005	2435	1189	2340	1921	3550	2005	2080	1211
	132	1733	1995	2600	2290	2718	1518	2084	1661	3100	2290	2320	1542
	160	1786	2035	2700	2290	2718	1523	2137	1707	3200	2290	2320	1547
	180	1852	2088	2800	2290	2718	1528	2202	1765	3300	2290	2320	1552
1400	200	1872	2101	2850	2290	2718	1530	2222	1782	3350	2290	2320	1554
	225	1933	2150	2950	2290	2718	1535	2282	1836	3450	2290	2320	1559
	250	1995	2201	3050	2290	2718	1540	2343	1893	3550	2290	2320	1564
	280	2101	2290	3200	2290	2718	1547	2447	1990	3700	2290	2320	1571
	315	2153	2331	3300	2290	2718	1552	2546	2084	3850	2290	2320	1578

* The above weight does not include motor and drive unit as these will vary with supplier.

All Dimensions in mm.

CW 90° (Pos Z)

CW 270° (Pos W)

CW 360° (Pos W)

CW 360° (Pos Z)

CCW 90° (Pos W)

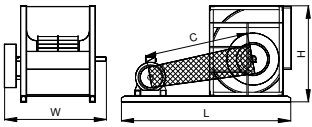
CCW 270° (Pos Z)

CCW 360° (Pos W)

CCW 360° (Pos Z)

Model	Motor Frame Size	90°/ 270°						360°					
		C (90°)	C (270°)	L	W	H	* Wt (kg)	C1	C2	L	W	H	* Wt (kg)
560	132	875	945	1400	1168	1080	155	968	792	1550	1168	942	157
	160	938	998	1500	1168	1080	156	1076	895	1700	1168	942	158
	180	1012	1064	1600	1168	1080	157	1100	917	1750	1168	942	158
	200	1038	1085	1650	1168	1080	157	1173	989	1850	1168	942	159
	225	1109	1149	1750	1168	1080	158	1242	1056	1950	1168	942	160
	250	1180	1214	1850	1168	1080	159	1312	1124	2050	1168	942	161
630	132	948	1034	1500	1316	1207	194	1082	886	1700	1316	1048	196
	160	1010	1085	1600	1316	1207	195	1140	940	1800	1316	1048	196
	180	1082	1149	1700	1316	1207	196	1211	1008	1900	1316	1048	197
	200	1107	1169	1750	1316	1207	196	1235	1030	1950	1316	1048	198
	225	1177	1230	1850	1316	1207	197	1301	1095	2050	1316	1048	198
	250	1247	1294	1950	1316	1207	198	1370	1161	2150	1316	1048	199
710	132	993	1095	1600	1420	1382	259	1162	941	1850	1420	1200	262
	160	1054	1144	1700	1420	1382	260	1220	994	1950	1420	1200	263
	180	1126	1207	1800	1420	1382	261	1290	1061	2050	1420	1200	264
	200	1199	1272	1900	1420	1382	263	1313	1082	2100	1420	1200	265
	225	1268	1333	2000	1420	1382	264	1379	1146	2200	1420	1200	266
	250	1338	1395	2100	1420	1382	265	1447	1211	2300	1420	1200	267
	280	1403	1453	2200	1420	1382	266	1559	1321	2450	1420	1200	269
800	160	1168	1273	1850	1528	1568	336	1363	1112	2150	1528	1354	342
	180	1191	1290	1900	1528	1568	337	1385	1132	2200	1528	1354	343
	200	1264	1353	2000	1528	1568	339	1455	1199	2300	1528	1354	345
	225	1331	1412	2100	1528	1568	341	1521	1261	2400	1528	1354	347
	250	1400	1472	2200	1528	1568	343	1587	1326	2500	1528	1354	349
	280	1464	1528	2300	1528	1568	345	1649	1386	2600	1528	1354	350
900	160	1286	1415	2000	1690	1748	386	1468	1188	2300	1690	1508	392
	180	1308	1431	2050	1690	1748	387	1536	1251	2400	1690	1508	394
	200	1380	1492	2150	1690	1748	389	1558	1270	2450	1690	1508	395
	225	1446	1548	2250	1690	1748	391	1621	1330	2550	1690	1508	397
	250	1513	1607	2350	1690	1748	393	1686	1392	2650	1690	1508	399
	280	1576	1660	2450	1690	1748	395	1795	1497	2800	1690	1508	401
	315	1683	1757	2600	1690	1748	398	1899	1599	2950	1690	1508	404
1000	180	1423	1565	2200	1875	1910	451	1644	1334	2550	1875	1640	457
	200	1445	1581	2250	1875	1910	452	1712	1397	2650	1875	1640	459
	225	1510	1635	2350	1875	1910	454	1774	1456	2750	1875	1640	461
	250	1576	1691	2450	1875	1910	455	1838	1516	2850	1875	1640	463
	280	1686	1789	2600	1875	1910	458	1897	1572	2950	1875	1640	465
	315	1792	1882	2750	1875	1910	461	2000	1671	3100	1875	1640	468
1120	180	1547	1715	2350	1946	2158	786	1815	1464	2750	1946	1850	797
	200	1616	1773	2450	1946	2158	789	1883	1527	2850	1946	1850	800
	225	1680	1827	2550	1946	2158	792	1945	1585	2950	1946	1850	802
	250	1746	1882	2650	1946	2158	794	2008	1645	3050	1946	1850	805
	280	1806	1932	2750	1946	2158	797	2067	1700	3150	1946	1850	808
	315	1911	2024	2900	1946	2158	801	2169	1798	3300	1946	1850	812
	355	2012	2112	3050	1946	2158	805	2266	1892	3450	1946	1850	816

* The above weight does not include motor and drive unit as these will vary with supplier.

All Dimensions in mm.

CW 90° (Pos Z)



CW 270° (Pos W)

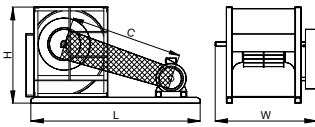

CW 360° (Pos W)

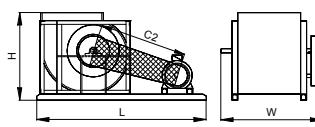

CW 360° (Pos Z)

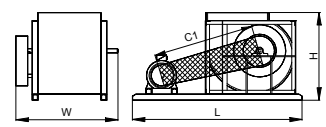

CCW 90° (Pos W)

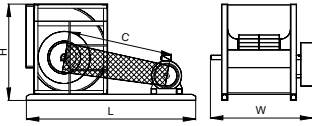

CCW 270° (Pos Z)

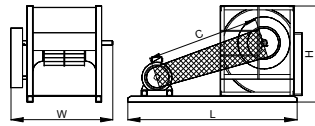

CCW 360° (Pos W)

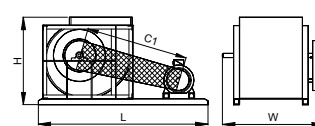

CCW 360° (Pos Z)

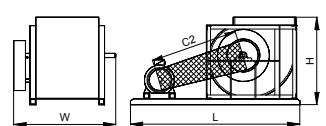

Model	Motor Frame Size	90° / 270°						360°					
		C (90°)	C (270°)	L	W	H	* Wt (kg)	C1	C2	L	W	H	* Wt (kg)
1250	180	1687	1886	2550	2065	2435	1189	1992	1596	3000	2065	2080	1210
	200	1755	1943	2650	2065	2435	1194	2058	1657	3100	2065	2080	1215
	225	1819	1995	2750	2065	2435	1198	2120	1714	3200	2065	2080	1220
	250	1883	2049	2850	2065	2435	1203	2182	1772	3300	2065	2080	1225
	280	1943	2097	2950	2065	2435	1208	2240	1825	3400	2065	2080	1230
	315	2046	2186	3100	2065	2435	1215	2340	1921	3550	2065	2080	1237
	355	2145	2272	3250	2065	2435	1222	2436	2013	3700	2065	2080	1244
1400	180	1852	2088	2800	2325	2718	1568	2202	1765	3300	2325	2320	1592
	200	1872	2101	2850	2325	2718	1570	2222	1782	3350	2325	2320	1594
	225	1933	2150	2950	2325	2718	1575	2282	1836	3450	2325	2320	1599
	250	1995	2201	3050	2325	2718	1580	2343	1893	3550	2325	2320	1604
	280	2053	2247	3150	2325	2718	1585	2447	1990	3700	2325	2320	1611
	315	2153	2331	3300	2325	2718	1592	2498	2037	3800	2325	2320	1616
	355	2250	2413	3450	2325	2718	1599	2592	2126	3950	2325	2320	1623

* The above weight does not include motor and drive unit as these will vary with supplier.

All Dimensions in mm.



Operational Limits - "FDA"

		160	180	200	225	250	280	315	355	400	450	500	560	630	710	800	900	1000	1120	1250	1400		
Maximum Absorbed Power	S-C	kW	2	2	2.5	3	3	4	5.5	5.5	7.5	11	11	15	18.5								
	T	kW				7.5	11	11	15	15	18.5	18.5	22	22	25	25	30	37	45	60	75	75	
	X	kW											37	37	45	45	75	75	110	130	150	150	
	S2-C2	kW				6	8	8	11	11	13	13											
	T2	kW							20	20	22	24	28	28									
Maximum Fan Speed	S-C	rpm	4200	3700	3300	2900	2700	2400	2100	1800	1600	1400	1200	1100	900	800							
	T	rpm				3000	2700	2200	2000	1800	1600	1300	1200	1000	900	750	650	600	450	400	350	350	
	X	rpm											1300	1100	1000	800	700	650	550	500	450	450	
	S2-C2	rpm				2200	2000	1600	1500	1500	1200	1000	900										
Temperature Range Min. -20°C	T2	rpm							1700	1400	1200	1000	900	750									
	S-C	Max.°C	85	85	85	85	85	85	85	85	85	85	85	85	85								
	T-X	Max.°C				100	100	100	100	100	100	100	100	100	100	100	100	100	100	100	100	100	100
	S2-C2	Max.°C				85	85	85	85	85	85	85											
	T2	Max.°C								100	100	100	100	100	100								
Wheel	Diameter	mm	160	180	200	225	250	280	315	355	400	450	500	560	630	710	800	900	1000	1120	1220	1400	
	Weight	kg	1.4	1.6	1.7	1.9	2.8	3.6	4.8	5.7	9.7	11.7	18.5	24.5	33	41.5	65	76	92	158	255	292	
Fan weight	J = PD² / 4		kgm ²	0.01	0.011	0.014	0.02	0.04	0.06	0.1	0.15	0.33	0.5	0.95	1.6	2.7	4.4	8.7	13.1	19.4	44.5	76.5	128.5
	S	kg	7	8	9	10.6	12	17	22	28	37	48	69	81	101	118							
	C	kg		9.5	10.5	12	15	20	24	32	41	51	74	93	104	127							
	T	kg					21	27	30	45	55	61	81	110	140	192	240	293	340	647	960	1300	1300
	X	kg												138	175	227	281	326	384	682	986	1340	1340
S2	kg					25	35	45	59	77	100	142											
C2	kg					32	43	52	69	88	108	155											
T2	kg								116	145	166	207	273	334									